

Design your Dreams

---

Services Applied  
FORM **Industrial** Engineering  
AESTHETICS Interior Research 3D Visualisation  
Function **Design** Style ART  
ERGONOMICS Prototype StartUP Assit Program

**Industrial Design Consultancy**

Creative firm having sole aim, to deliver Quality service



The company offers a range of engineering and R&D services to diverse clients, assisting in **new product development** and product lifecycle management through services in the areas of **product design, simulation, engineering drafting, computer-aided engineering design and manufacturing**. We have **developed solutions for OEM, SMS customers all over India**. G2Design truly believe -**Make in India** initiative be followed global Indian success stories.

**Ideations to manufacturing** with meticulous engineering within short period and **affordable cost**.

**G2Design**

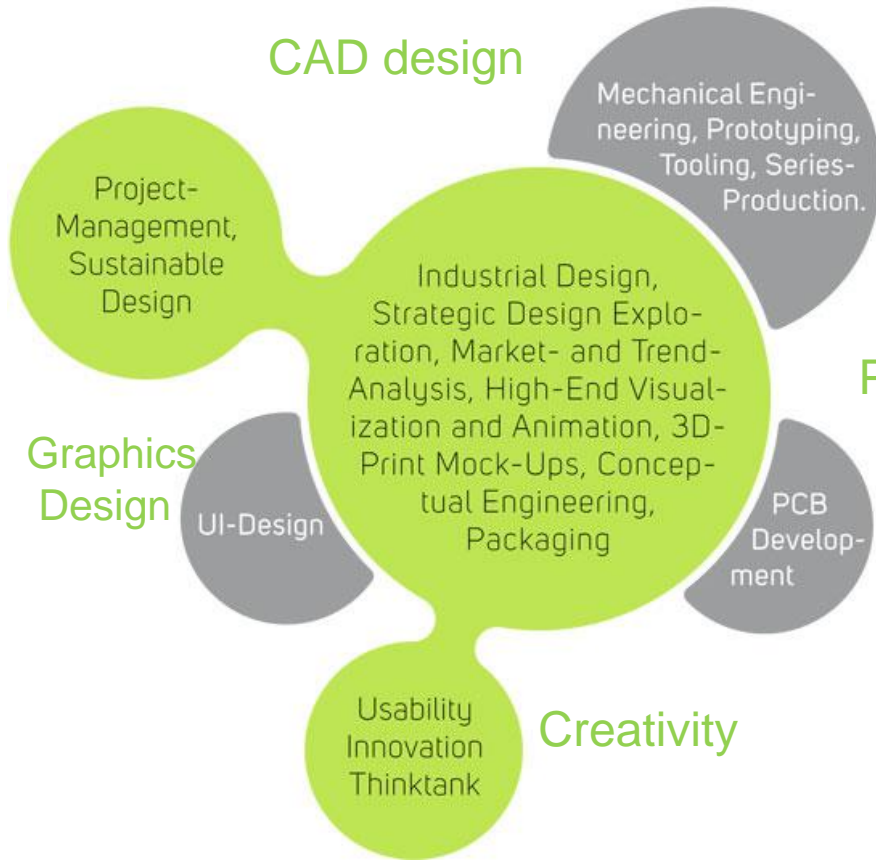

**Product design**  
**Engineering design**  
**Interior design**  
**Graphics Design**

Industrial Design Centre is one of the oldest and premier design schools in India, established in 1969 by the Government of India at the campus of the Indian Institute of Technology Bombay.



**IDC**  
**IIT Bombay**  
**Master Of Design**

---

**Mentors**

**G2Design**

G2DESIGN edge lies in the vast field experience and the innovative strength. Many experts from R&D Departments, Academicians, Scientists, Consultants are **associated** with us for achieving our goal of customer satisfaction with technical excellence and professional ethics



R S JAGATP & ASSOCIATE



Aakar Studio



WINGS 44

Our clients range from start-ups, medium-sized businesses to the world's leading enterprises. All clients have one thing in common the demand for maximum quality from concept to visual excellence. Many of our clients have been working with us for several years and decades, underlining the quality of collaboration and results.



Together we elaborate their long-term visions and goals, plan and design complete product lines and product portfolios by applying a strategic and holistic brand approach.

Clients of growth

**G2Design**

# Automotive



---

**CASE STUDY** Central Console

**G2Design**



Brief:

Redesign Project

Developing the new central console with existing style.

The constraints was no change in position of the air vents and the central controls. Taking this as challenge

G2design was given the task to redesign

a new Packaging .more over the position of

the Window controls and Gear shift remains same.

Study  
Survey  
Brain storming  
Pencil Sketches

Concept  
3d model rendering

Mocup in thermalcol  
Final Prototype  
done in Clay

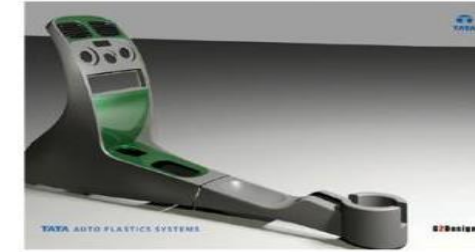
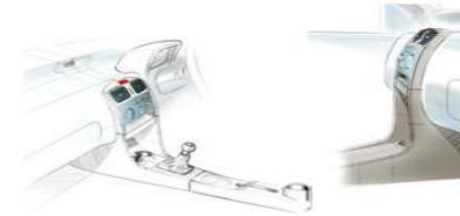
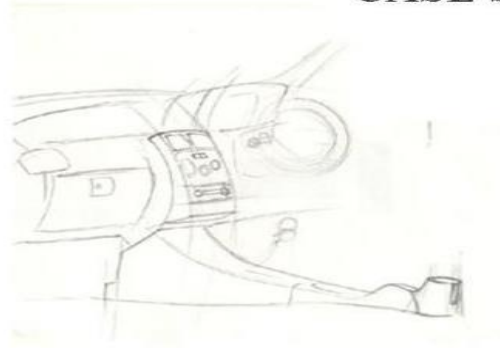

CASE STUDY



TATA AUTO PLASTICS SYSTEMS

3D rendering submitted

G2Design



3D and Actual production

**G2Design**



---

Case study Interior DASH board

**G2Design**



Interior DASH board

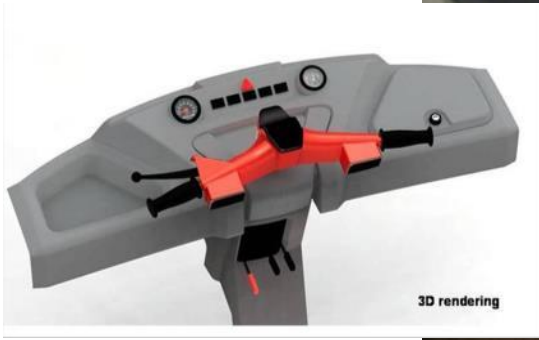

Interior DASH board



BUS AND TRUCKS

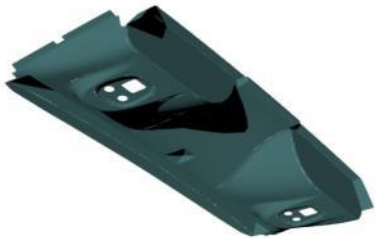

CAD MODEL



Fiber Model







We delivered in line to input design brief with additional new usability feature on the interior design.

**VOLVO Bus India Project**

**G2Design**



---

**G2Design**



## Assembly

In the course of many years cooperating, G2Design **delivered innovative and successful design solutions.**

We not only deliver a wide range of ideas and concepts, also our client are convinced with high technical understanding in the detailing phase.

Mr. Pankaj Kasliwal , VP , Volvo

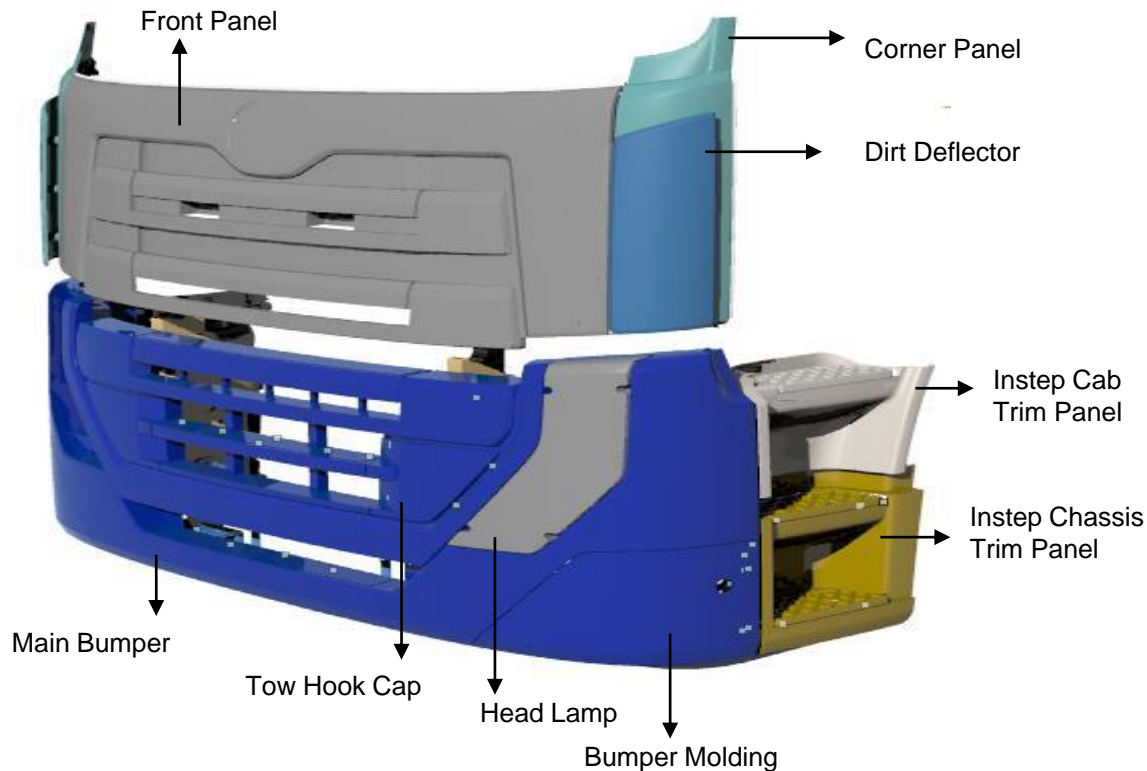

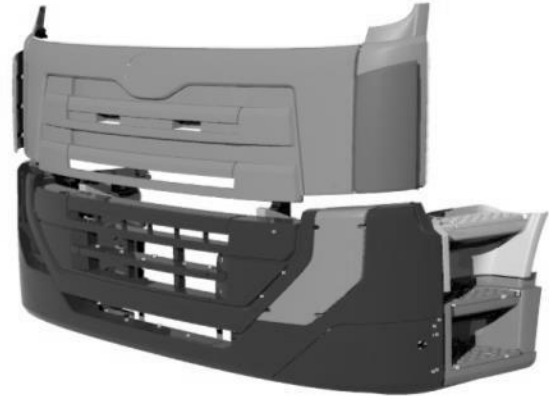

**VOLVO Truck India Project**

**G2Design**



G2Design delivered a **perfect design result**. And they offered **full-service with a efficient working network** from mechanical engineering and prototypes and pilot lot supply .

Abhay Dandekar , Head Body and trim, Magna



We work with organizations seeking growth, influence, and agility to design and build the next generation of products, services, and experiences



**cello**<sup>®</sup>



---

**Consumer**

**G2Design**



Plastics

**G2Design**



Plastics

**G2Design**



# Multipurpose cart



- Easy toeing and rotating
- Multiple storage system - vegetables, ice creams, cold drinks, etc
- Top acts as a lid and can be closed

views



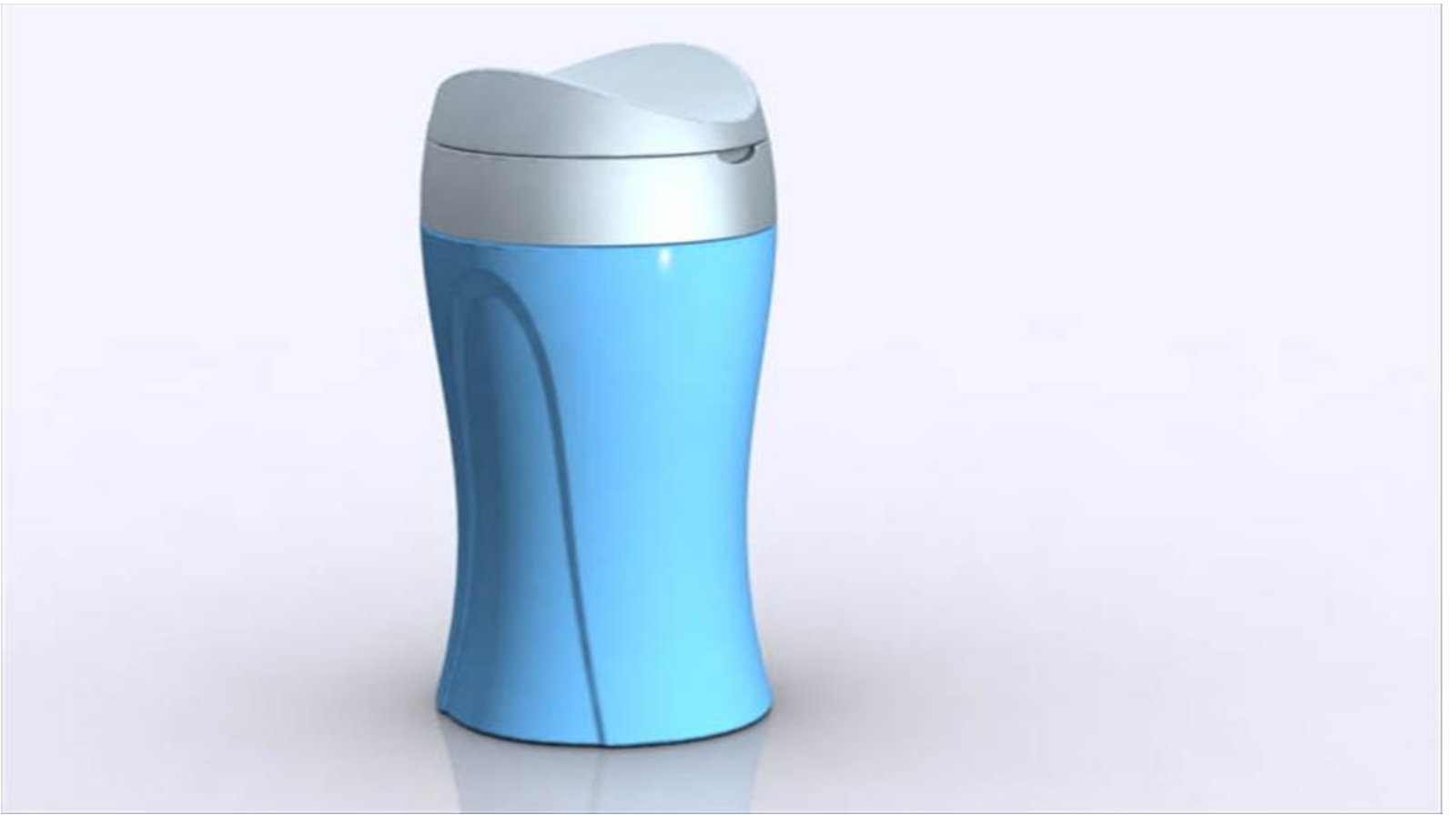

Plastics

**G2Design**



Existing



Proposed



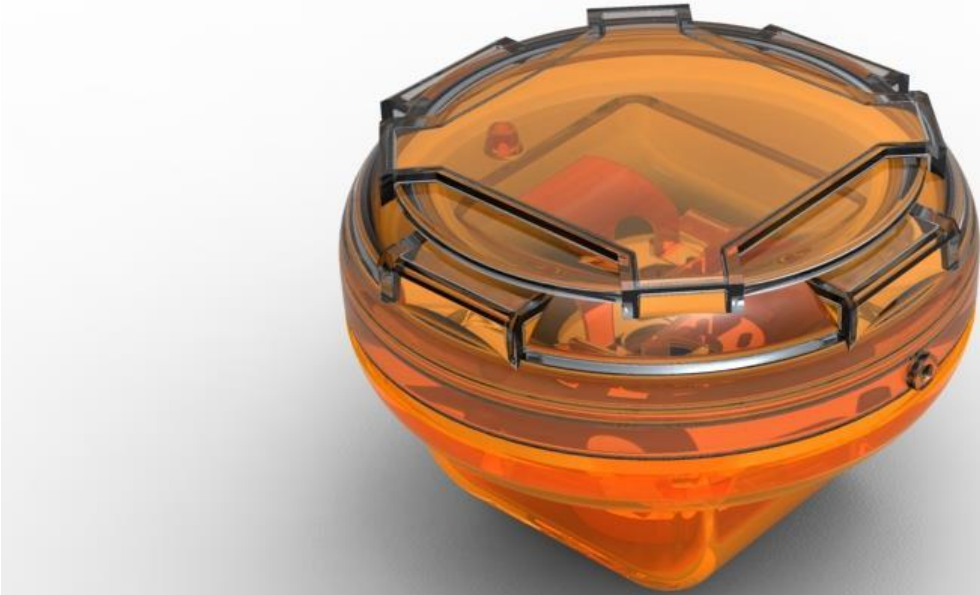

---

Casting metal-Plastics

**G2Design**

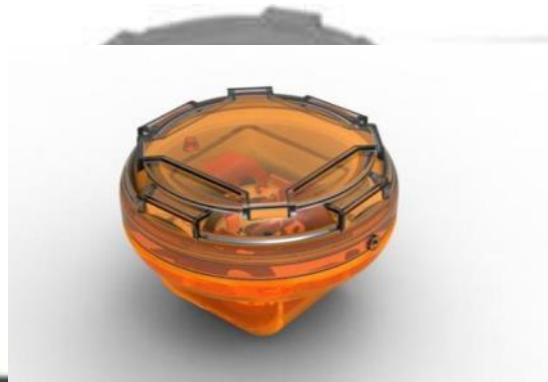

Ultrasonic flowmeter

Sends your meter reading

through SMS



Casting metal

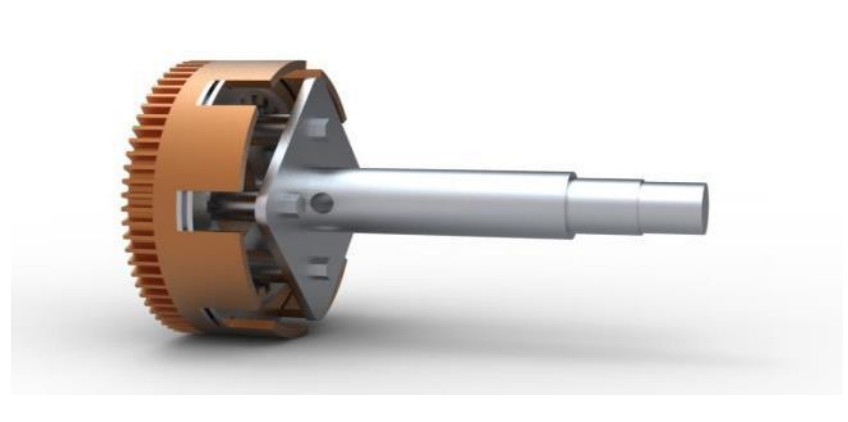

Casting metal

**G2Design**



# Capital Equipment Design

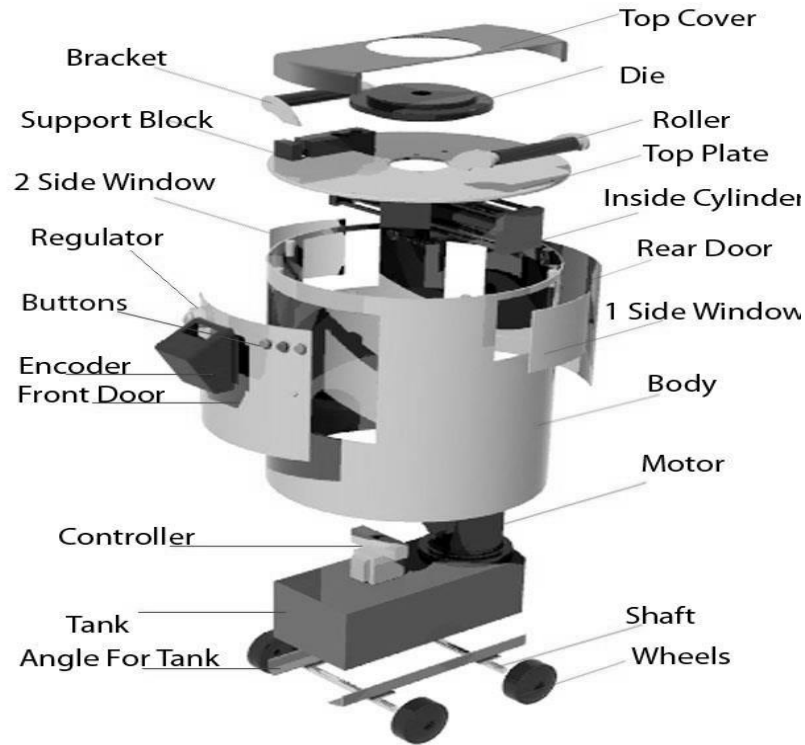

**Cosmos**  
BAR Bending



Before



After



Sheet metal

**G2Design**



EDUCATION E PODIUM

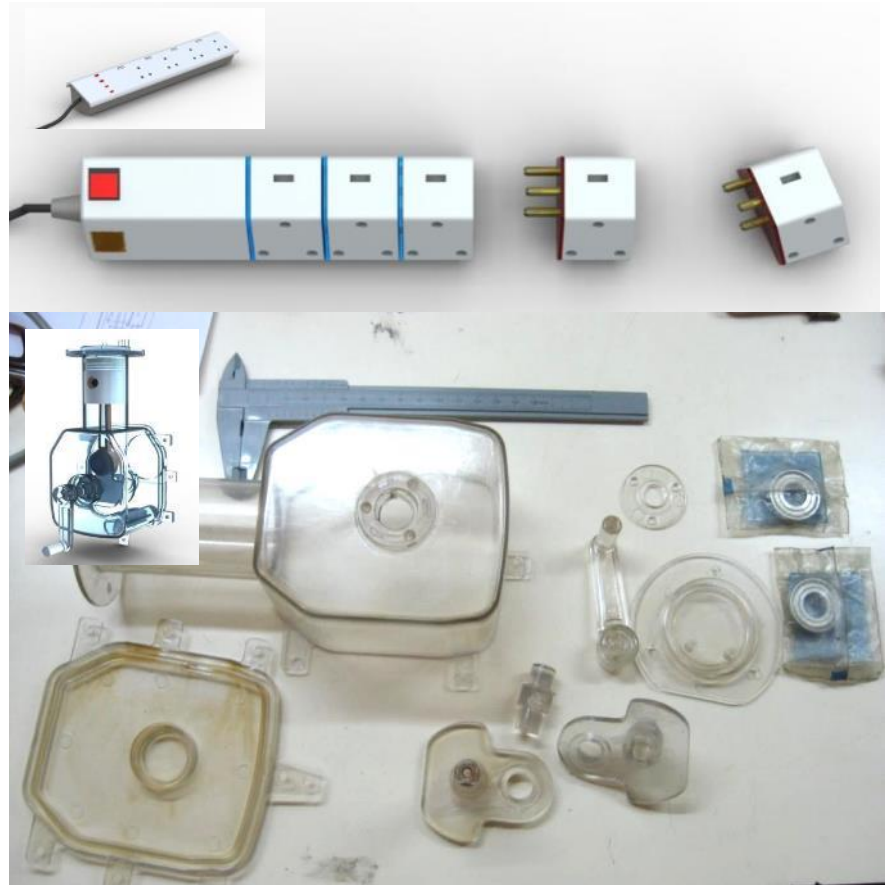
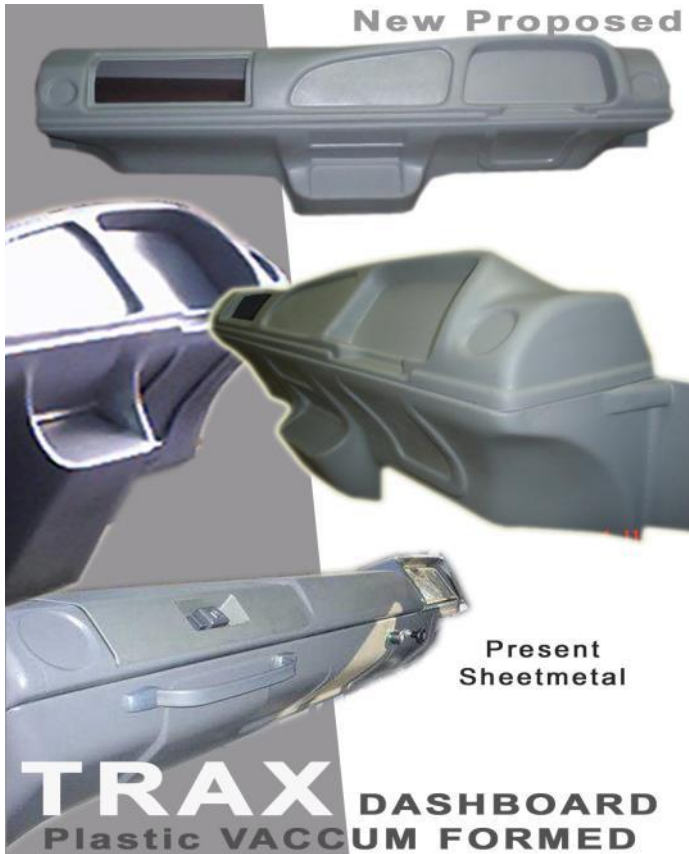

Plastic product

**G2Design**

Water Heater

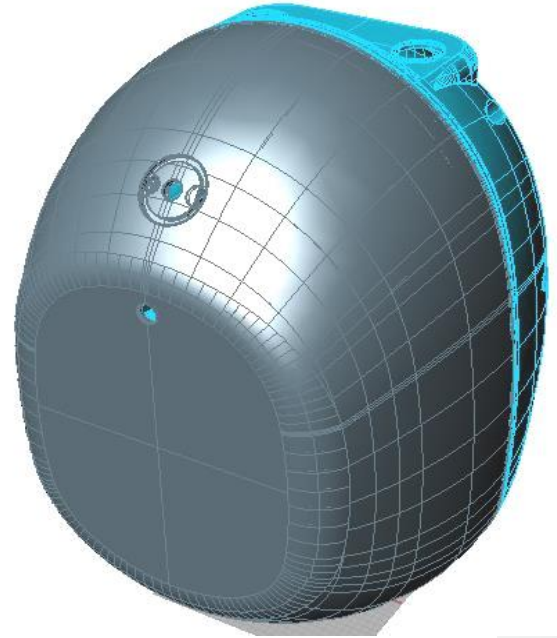
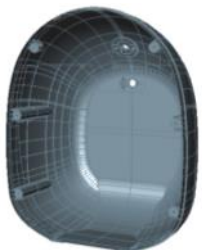
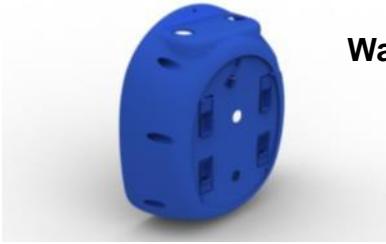

Chetas Controls

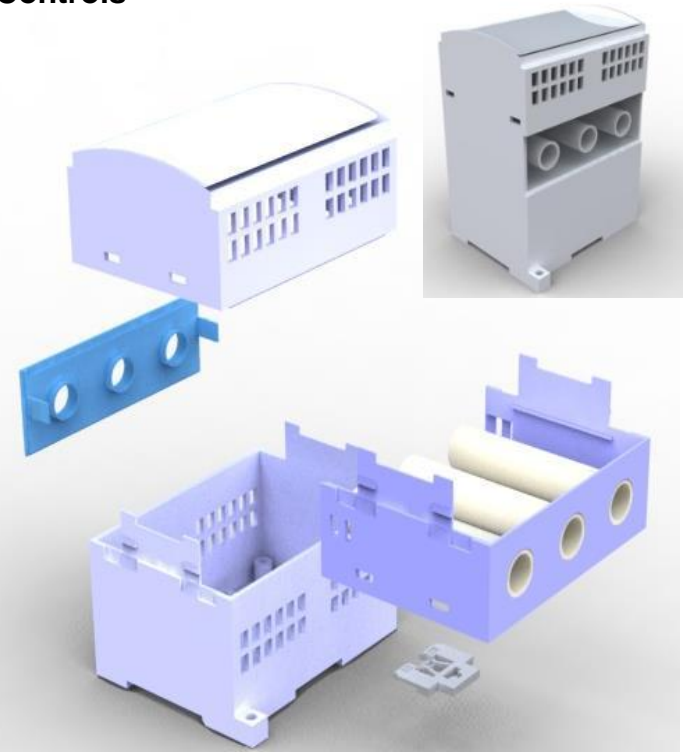



Corporate Product Kiosk and Branding

Prototype



Aakar Studio association

Prototype in various material

**G2Design**

Interior Design

---

Hospital Furniture

**G2Design**





ICU and OT Area



OPERATION COMPLEX

Corporate and specialized in Hospital Interior Design

**G2Design**



Corporate furniture

On going project



Corporate furniture

**G2Design**

# Heath Care

SAMEER / EVOLVE

---

Heath Care

**G2Design**

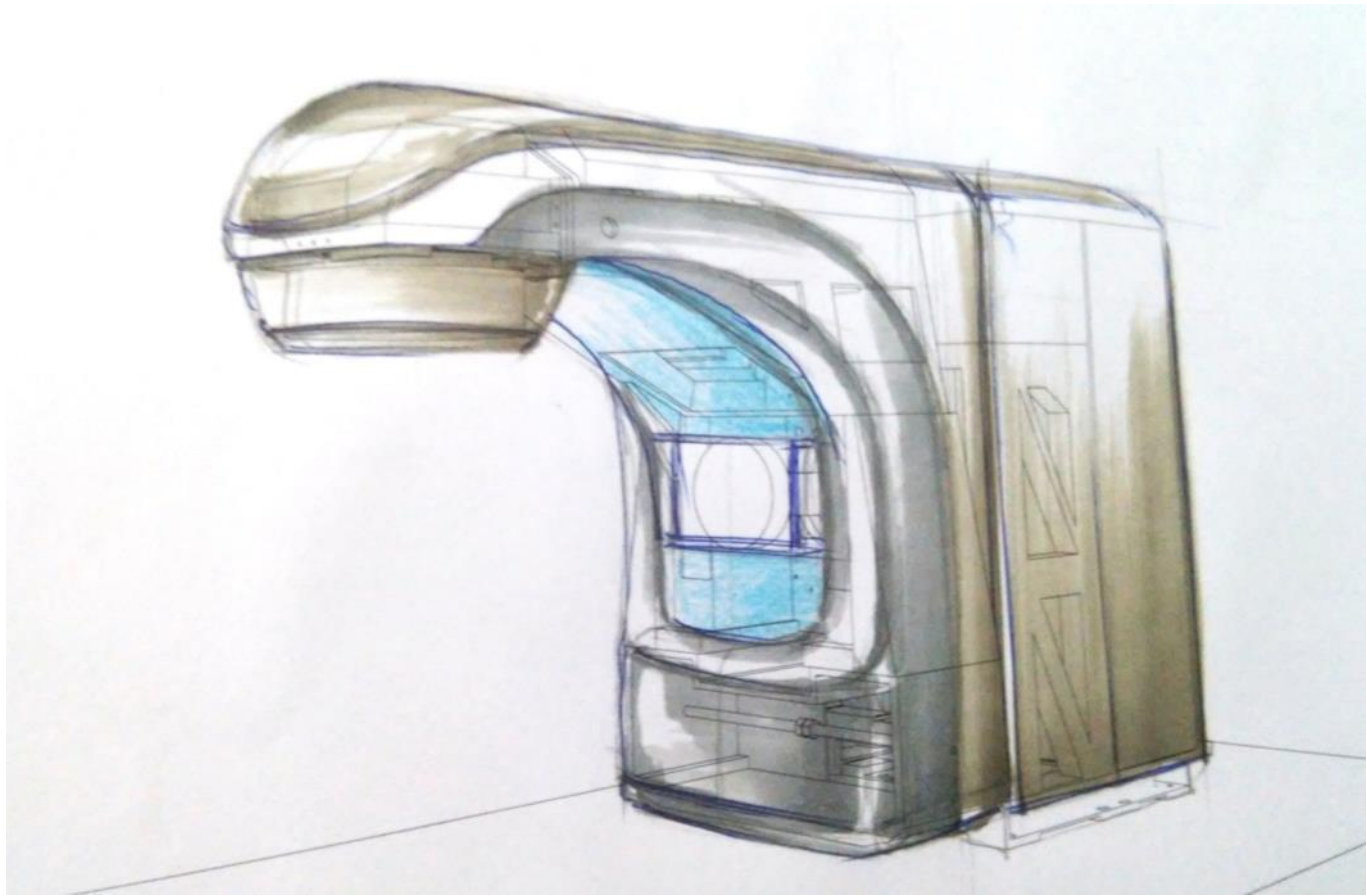

Rough Ideation sketch

**G2Design**

# Society for Applied Microwave Electronics Engineering & Research

Government of India

On going project

## Health Care Product

Need the vital understanding of the product engineering detailing

G2Design was successful in delivering the to the best in quality and standard

SAMEER is the only organization in the country which has developed LINAC machines for medical applications.

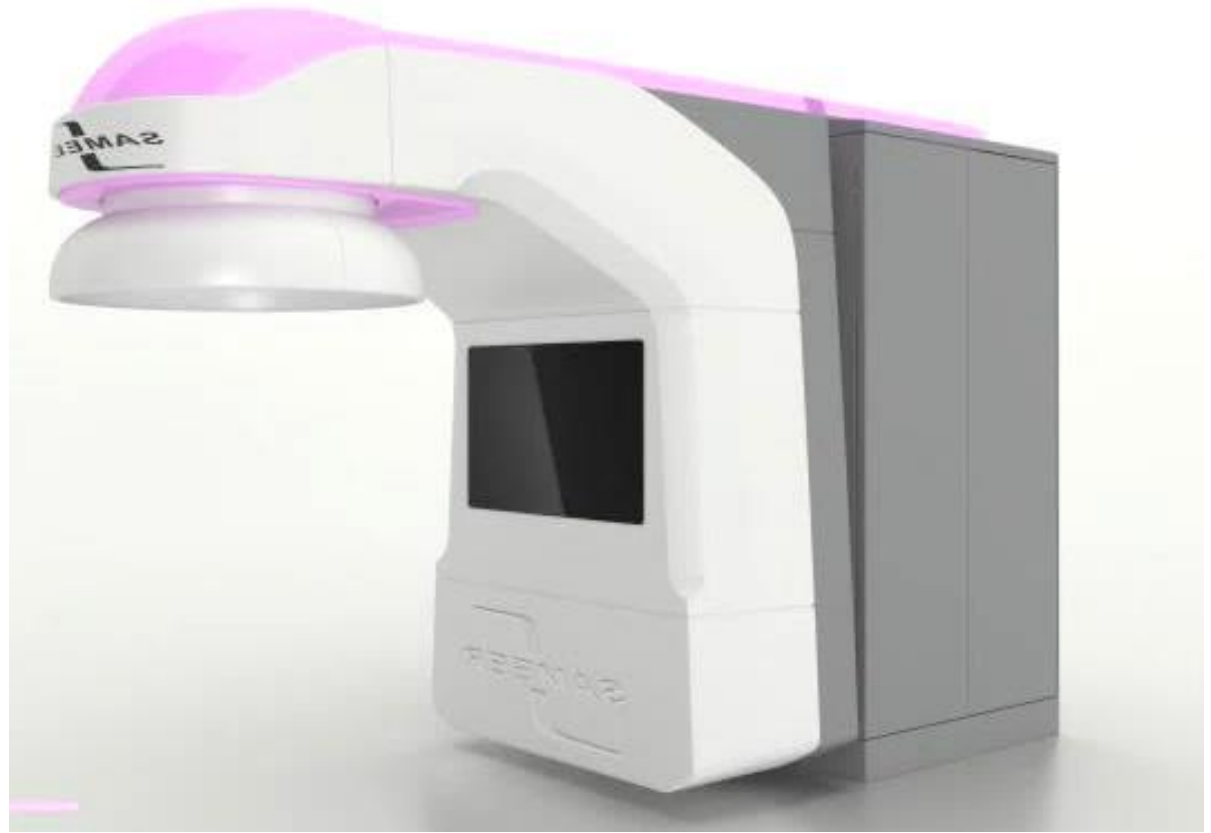

Engineering CAD Deliverable

**G2Design**



## Health Care Product

G2DESIGN we look forward for the consistently smart work team .G2Design will cater to all our with next generation of products, services, and experiences.

Mr. TONDON , MD, Evolve Technologies

In Pipe line project

**Upcoming Project**



On going project



e-Rick  
Exterior Styling

## Upcoming Project

- Medical Tablets **Dispensing Machine**
- **Tractor** Exterior Styling
- Eco friendly product range in Tableware
- 100 Bed Multi Speciality Hospital Interior



## Contact Us

Design your Dreams with us.

## Our Address

G2Design  
Sanskriti Arcade, Office No 406 ,  
Business Center,  
opp PCMC school,  
Wakad, Pune-411039  
Maharashtra ,India



Contact number-830 860 6565

[www.g2designindia.com](http://www.g2designindia.com)

Email Address

W:[info@g2designindia.com](mailto:info@g2designindia.com)

E: [g2designindia@gmail.com](mailto:g2designindia@gmail.com)

We look forward to work with esteem organizations seeking growth,  
influence, and agility to design  
&  
build the next generation of products, services, and experiences

*Design your Dreams*

Thank You

